

MCX Type RF Coaxial Connector Series

The series of MCX radio frequency connector is a kind is since pushed the lock type joining device small-scaly, it has a small, light, characteristic with compact structure. Small-scale electronic equipment or network system that can be used for requiring to volume, weight and installation way.

Interface Mating Dimensions

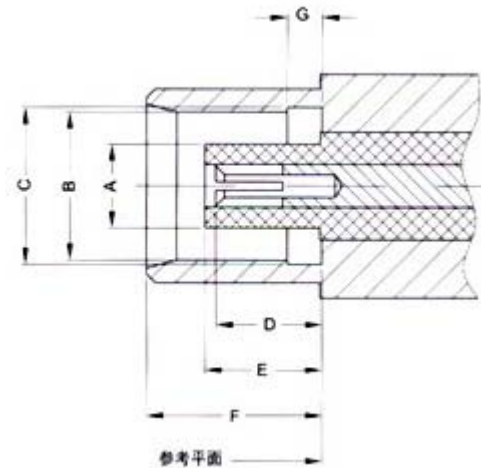
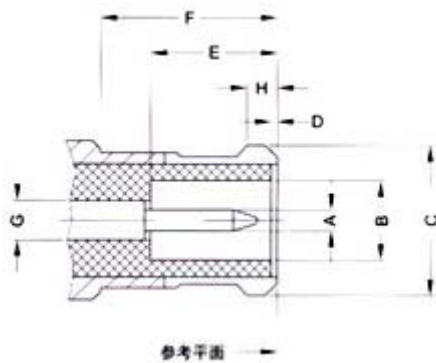

Plug		
Code	Millimeters	
	Min	Max
A	0.48	0.53
B	2.00	2.07
C	3.72	3.80
D	0.00	0.30
E	2.80	3.20
F	4.16	-
G	0.95nom	
H	0.70	0.75

Jack		
Code	Millimeters	
	Min	Max
A	1.80	1.98
B	3.42	3.48
C	3.61	3.76
D	2.31	2.79
E	2.61	2.79
F	4.00	4.12
G	0.75	0.85

Technical Specifications

Temp. Range	-65 ~ +165	Insulation Resistance	1000 m
Impedance	50 , 75	VSWR	<i>Straight</i> 1.15
Frequency Range	DC ~ 6GHZ		<i>Right Angle</i> 1.25
Working Voltage	250V (50) 170V (75)	Durability (mating)	≥ 500 (cycles)
Contact Resistance	<i>Center Contact</i> 5 m <i>Outer Contact</i> 2.5 m	Withstand Voltage	750V (50) 250V (75)

Material & Plating

Shell	Brass	<i>Gold plated</i>
Elastic contact	Beryllium Brass	<i>Gold plated</i>
Contact Pin	Brass	<i>Gold plated</i>
Socket	Beryllium Brass	<i>Gold Plated</i>
Insulator	PTFE	
Crimping suite	Copper Alloy	<i>Nickel or Gold plated</i>
O-ring Sealing	6146 Silastic	

Applicable Standard

CECC 22340, IEC61169-36

RF Coaxial Connector for Flexible Cable

Item Number: MCX-C-J1.5

Cable Type SFF-50-1.5-1
RG-174/U

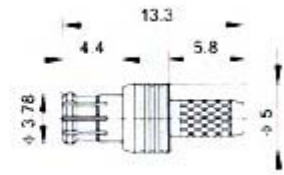

Item Number: MCX-C-J3

Cable Type SYV-50-3
RG-58/U

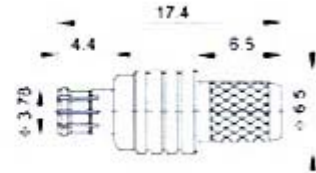

Item Number: MCX-C-JW1.5

Cable Type SFF-50-1.5-1
RG-174/U

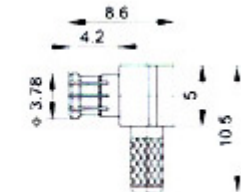

Item Number: MCX-C-JW1.5-3

Cable Type SFF-50-1.5-1
RG-174/U

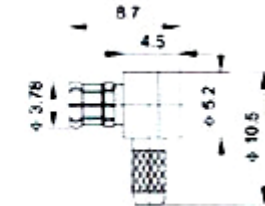

Item Number: MCX-C-k1.5

Cable Type SFT-50-1.5-1
RG-174/U

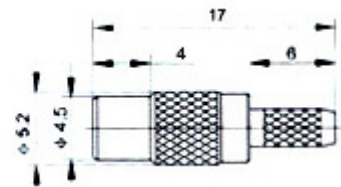

Item Number: MCX-1.5 Square

Cable Type SFT-50-1.5-1
RG-174/U

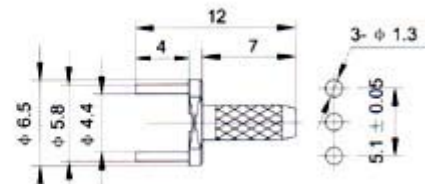

Item Number: MCX-1.5 Round

Cable Type SFT-50-1.5-1
RG-174/U

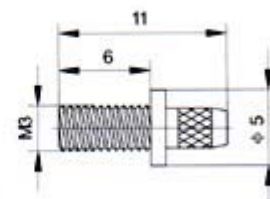

RF Coaxial Connector for Semi-rigid Cable

Item Number: MCX-C-JB2

Cable Type SFF-50-2
RG-405/U

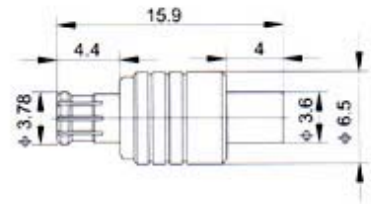

Item Number: MCX-C-JWB2

Cable Type SFF-50-2
RG-405/U

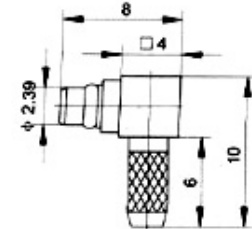

Item Number: MCX-C-JWB3

Cable Type SFF-50-2
RG-405/U

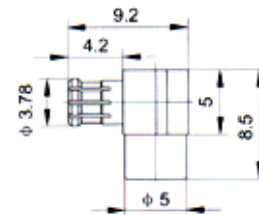

Printed Circuit Board (PCB) Connector

Item Number: MCX-KE

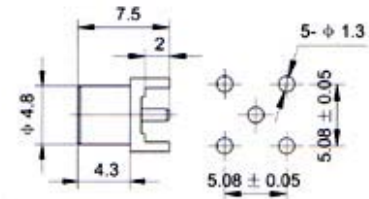

Item Number: MCX-KE-1

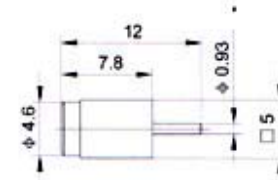

Item Number: MCX-KE-2

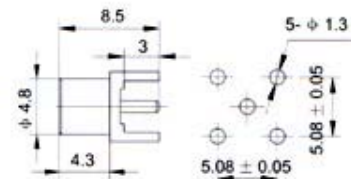

Item Number: MCX-KWE

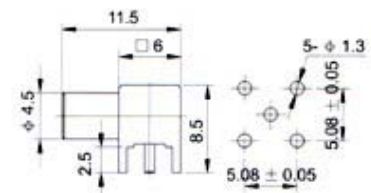

Item Number: MCX-KWE-2

